

*A  
S  
H*

TIMBER RANGE door handles are manufactured in quality hardwood from sustainable sources and Forestry Stewardship Council approved suppliers. All Handles comply with Document M and DDA WARM TO TOUCH requirements.

# ASH500 Timber Range



## Technical Specification

### Detailed Photography



### Technical Illustration

60

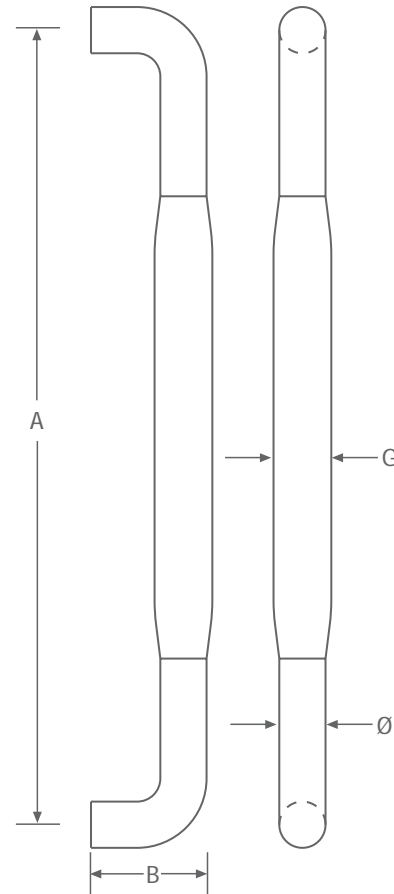

Style	Diameter $\varnothing$	Centres(A)	Projection(B)	Overrun(D)	Grip(G)	Finish	Code
ASH 500	32	up to 1200	95	NA	50	Iroko	IR
						American Oak	AO
						Maple	MP
						Mahogany	BM
						Polished Stainless	PS
						Satin Stainless	SS

\*\* Extra fixing points may be required on some sizes.  
Contact our technical department for assistance.

### Ordering Guide

Please use the following guide as an example when placing an order.

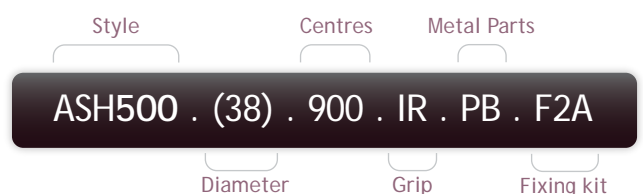

More ordering and fixing information can be found at the back of this catalogue

**ASH 500**

# ASH503 Timber Range



## Technical Specification

### 61 Detailed Photography

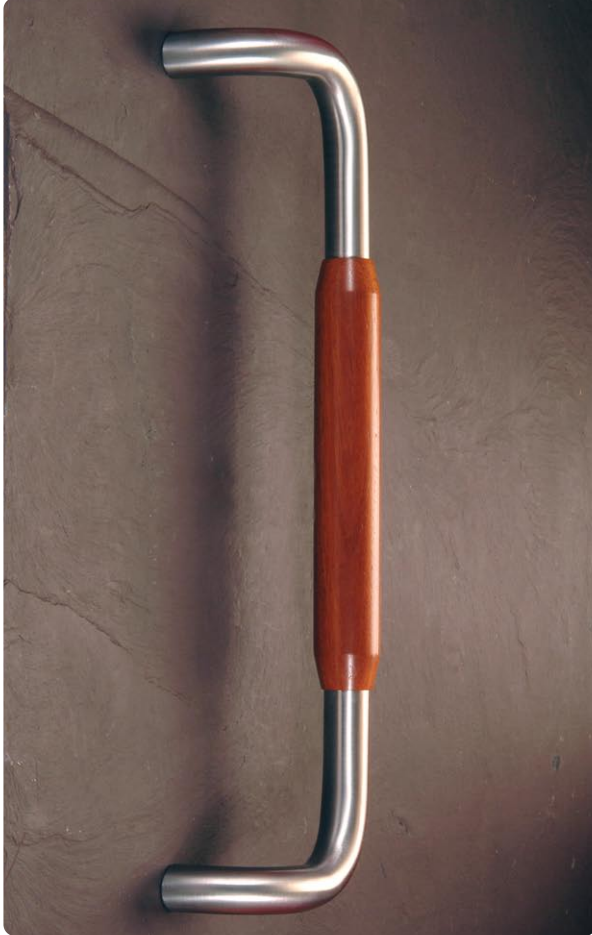

### Technical Illustration

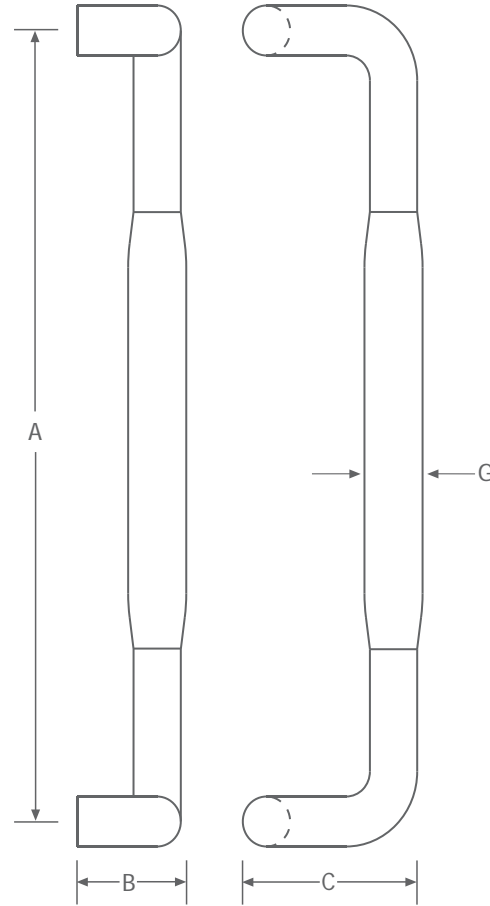

Style	Diameter $\varnothing$	Centres(A)	Projection(B)	Throw(C)	Grip(G)	Finish	Code
ASH 503	32	up to 1200	95	150	50	Iroko	IR
						American Oak	AO
						Maple	MP
						Mahogany	BM
						Polished Stainless	PS
						Satin Stainless	SS

\*\* Extra fixing points may be required on some sizes.  
Contact our technical department for assistance.

### Ordering Guide

Please use the following guide as an example when placing an order.

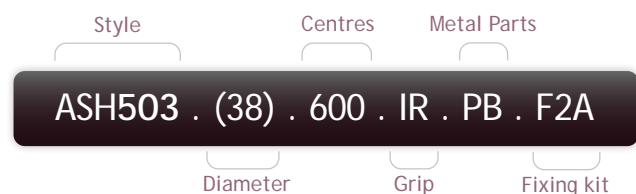

**ASH 503**

More ordering and fixing information can be found at the back of this catalogue

# ASH520 Timber Range



## Technical Specification

### Detailed Photography



### Technical Illustration

62

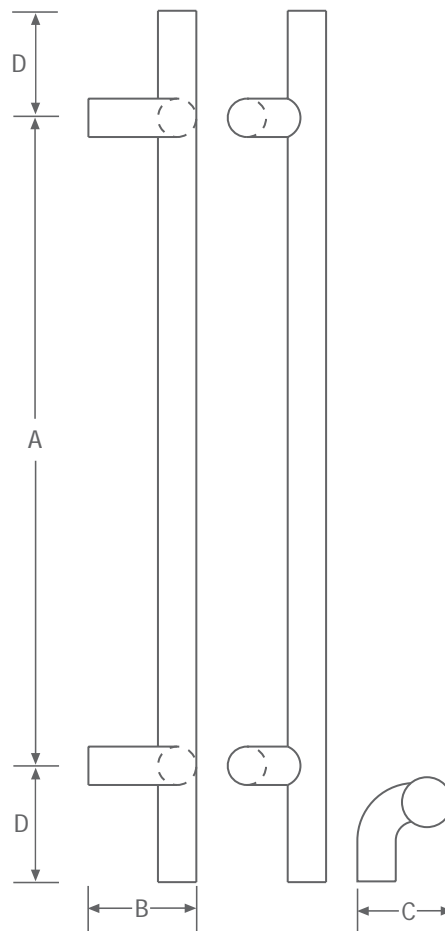

Style	Diameter $\varnothing$	Centres(A)	Projection(B)	Throw(C)	Overrun(D)	Finish	Code
ASH 520	32	up to 500	80	102	85	Iroko	IR
ASH 520	38	up to 900	83	108	85	American Oak	AO
ASH 520	50	up to 1800	88	120	85	Maple	MP
						Mahogany	BM
						Polished Stainless	PS
						Satin Stainless	SS

\*\* Extra fixing points may be required on some sizes.  
Contact our technical department for assistance.

### Ordering Guide

Please use the following guide as an example when placing an order.

Style                      Centres                      Metal Parts

ASH520 . (38) . 900 . IR . SS . F2A

Diameter                      Grip                      Fixing kit

More ordering and fixing information can be found at the back of this catalogue

**ASH 520**

# ASH521 Timber Range



## Technical Specification

### 63 Detailed Photography



### Technical Illustration

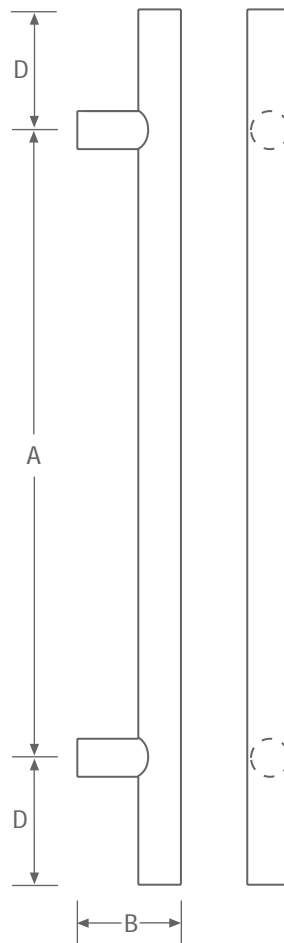

Style	Diameter $\varnothing$	Centres(A)	Projection(B)	Throw(C)	Overrun(D)	Finish	Code
ASH 521	32	up to 500	80	NA	85	Iroko	IR
ASH 521	38	up to 900	80	NA	85	American Oak	AO
ASH 521	50	up to 2000	95	NA	85	Maple	MP
						Mahogany	BM
						Polished Stainless	PS
						Satin Stainless	SS

\*\* Extra fixing points may be required on some sizes. Contact our technical department for assistance.

### Ordering Guide

Please use the following guide as an example when placing an order.

Style
Centres
Metal Parts

ASH521 . (38) . 600 . IR . PB . F2A

Diameter
Grip
Fixing kit

**ASH521**

More ordering and fixing information can be found at the back of this catalogue





# ASH576 Timber Range



## Technical Specification

### Detailed Photography



### Technical Illustration

66

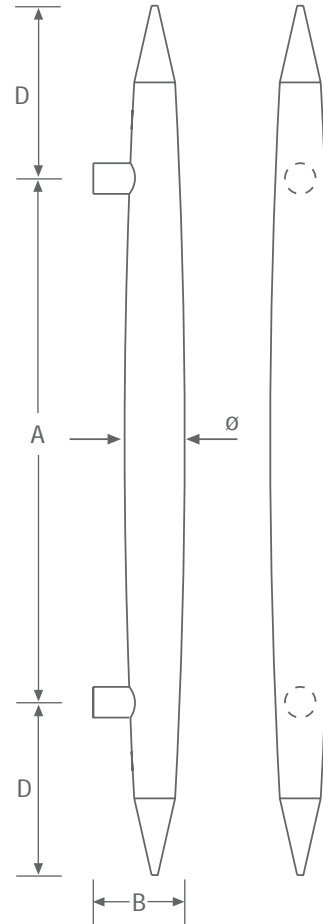

Style	Diameter $\varnothing$	Centres(A)	Projection(B)	Throw(C)	Overrun(D)	Finish	Code
ASH 576	50	up to 1800	***	NA	150	Iroko	IR
						American Oak	AO
						Maple	MP
						Mahogany	BM
						Polished Stainless	PS
						Satin Stainless	SS

\*\* Extra fixing points may be required on some sizes.  
Contact our technical department for assistance.  
\*\*\* Contact office for details.

### Ordering Guide

Please use the following guide as an example when placing an order.

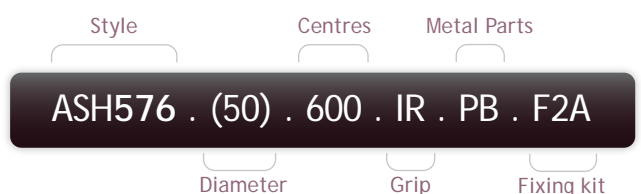

More ordering and fixing information can be found at the back of this catalogue

**ASH 576**

# ASH578 Timber Range



## Technical Specification

### 67 Detailed Photography



### Technical Illustration

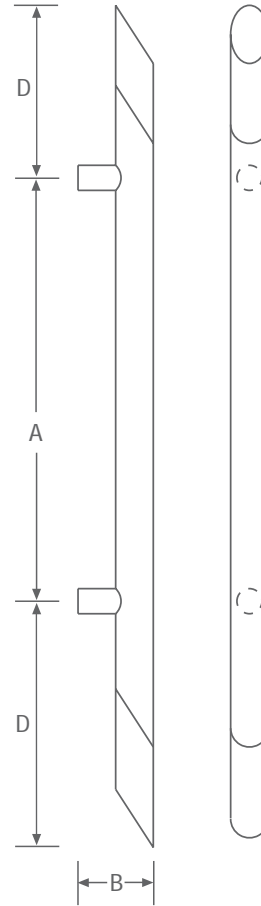

Style	Diameter $\varnothing$	Centres(A)	Projection(B)	Throw(C)	Overrun(D)	Finish	Code
ASH 578	38	up to 900	80	NA	150	Iroko	IR
ASH 578	50	up to 1800	95	NA	150	American Oak	AO
						Maple	MP
						Mahogany	BM
						Polished Stainless	PS
						Satin Stainless	SS

\*\* Extra fixing points may be required on some sizes.  
Contact our technical department for assistance.

### Ordering Guide

Please use the following guide as an example when placing an order.

Style
Centres
Metal Parts

ASH578 . (38) . 600 . IR . SS . F2A

Diameter
Grip
Fixing kit

**ASH578**

More ordering and fixing information can be found at the back of this catalogue

# ASH579 Timber Range



## Technical Specification

### Detailed Photography



### Technical Illustration

68

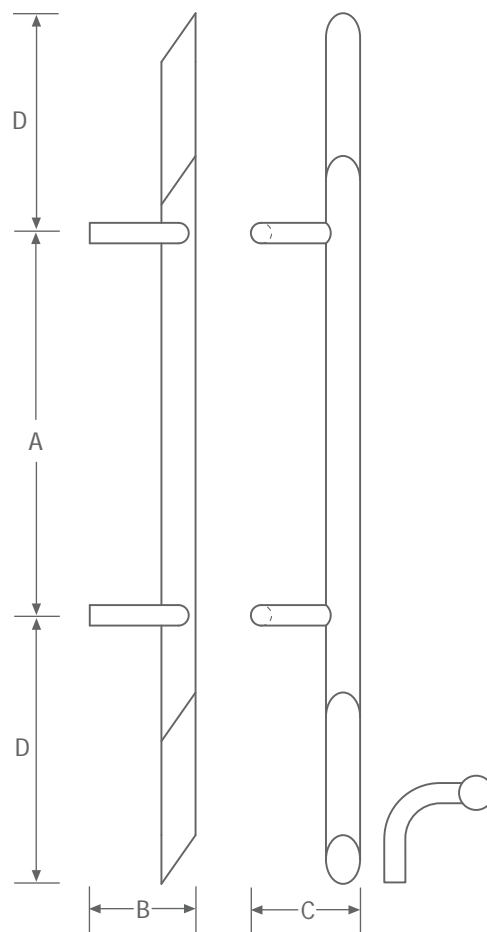

Style	Diameter $\varnothing$	Centres(A)	Projection(B)	Throw(C)	Overrun(D)	Finish	Code
ASH 579	38	up to 900	83	108	150	Iroko	IR
ASH 579	50	up to 1800	88	120	150	American Oak	AO
						Maple	MP
						Mahogany	BM
						Polished Stainless	PS
						Satin Stainless	SS

\*\* Extra fixing points may be required on some sizes. Contact our technical department for assistance.

### Ordering Guide

Please use the following guide as an example when placing an order.

Style
Centres
Metal Parts

ASH579 . (38) . 600 . IR . PB . F2A

Diameter
Grip
Fixing kit

More ordering and fixing information can be found at the back of this catalogue

**ASH 579**

# ASH580 Timber Range



## Technical Specification

### 69 Detailed Photography



### Technical Illustration

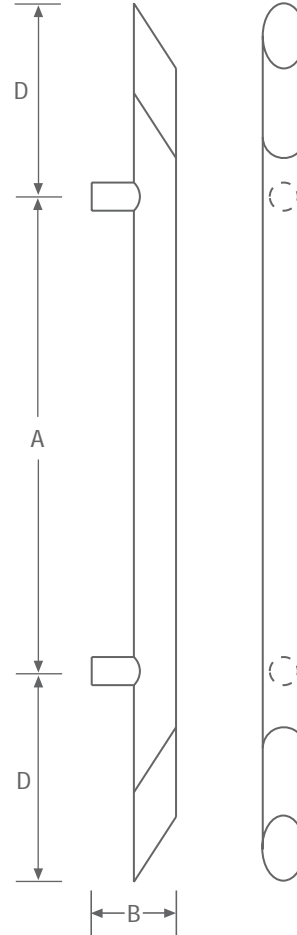

Style	Diameter $\varnothing$	Centres(A)	Projection(B)	Throw(C)	Overrun(D)	Finish	Code
ASH 580	38	up to 900	80	NA	150	Iroko	IR
ASH 580	50	up to 1800	95	NA	150	American Oak	AO
						Maple	MP
						Mahogany	BM
						Polished Stainless	PS
						Satin Stainless	SS

\*\* Extra fixing points may be required on some sizes.  
Contact our technical department for assistance.

### Ordering Guide

Please use the following guide as an example when placing an order.

Style
Centres
Metal Parts

ASH580 . (38) . 600 . IR . PB . F2A

Diameter
Grip
Fixing kit

**ASH 580**

More ordering and fixing information can be found at the back of this catalogue

# ASH581 Timber Range



## Technical Specification

### Detailed Photography

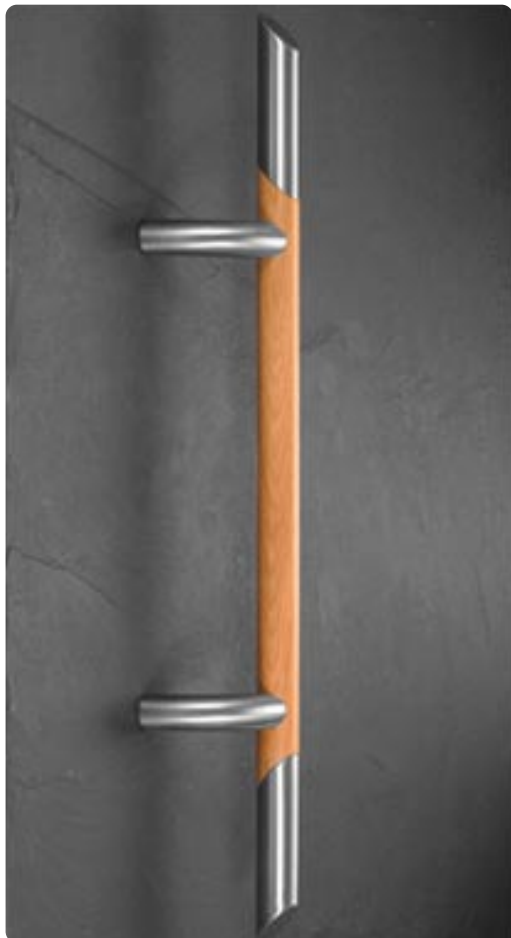

### Technical Illustration

70

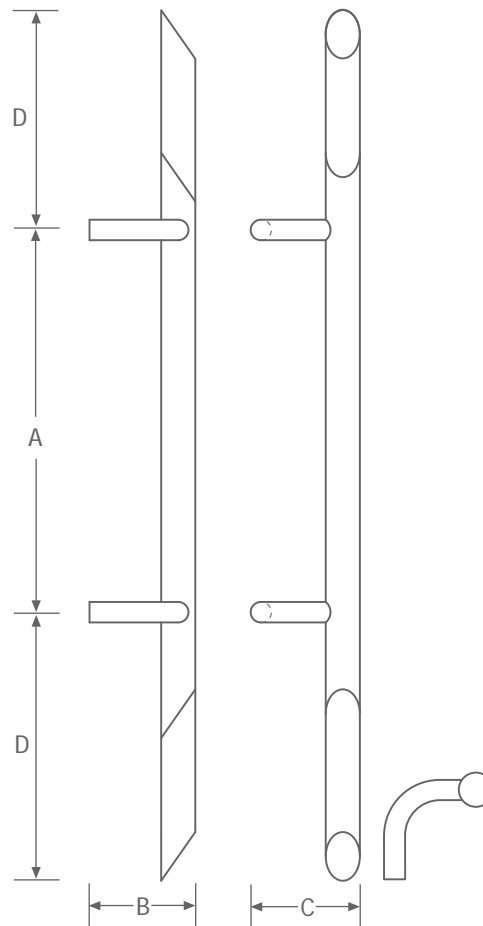

Style	Diameter $\varnothing$	Centres(A)	Projection(B)	Throw(C)	Overrun(D)	Finish	Code
ASH 581	38	up to 900	83	108	150	Iroko	IR
ASH 581	50	up to 1800	88	120	150	American Oak	AO
						Maple	MP
						Mahogany	BM
						Polished Stainless	PS
						Satin Stainless	SS

\*\* Extra fixing points may be required on some sizes.  
Contact our technical department for assistance.

### Ordering Guide

Please use the following guide as an example when placing an order.

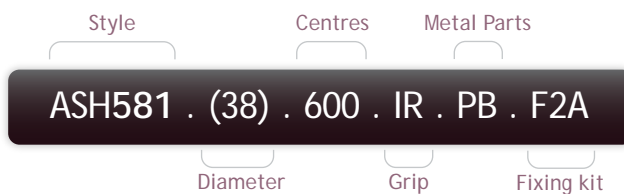

More ordering and fixing information can be found at the back of this catalogue

**ASH 581**

# ASH582 Timber Range



## Technical Specification

### 71 Detailed Photography



### Technical Illustration

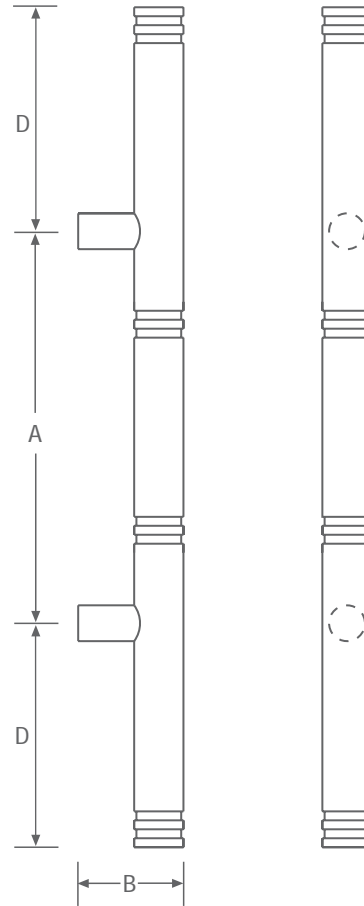

Style	Diameter $\varnothing$	Centres(A)	Projection(B)	Throw(C)	Overrun(D)	Finish	Code
ASH 582	38	up to 900	80	NA	150	Iroko	IR
ASH 582	50	up to 1800	80	NA	150	American Oak	AO
						Maple	MP
						Mahogany	BM
						Polished Stainless	PS
						Satin Stainless	SS

\*\* Extra fixing points may be required on some sizes.  
Contact our technical department for assistance.

### Ordering Guide

Please use the following guide as an example when placing an order.

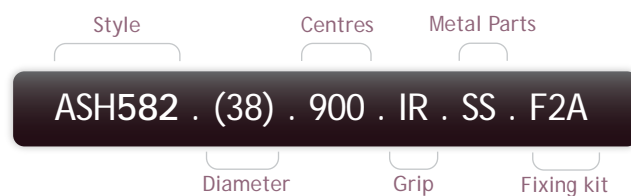

**ASH 582**

More ordering and fixing information can be found at the back of this catalogue

# ASH586 Timber Range



## Technical Specification

### Detailed Photography



### Technical Illustration

72

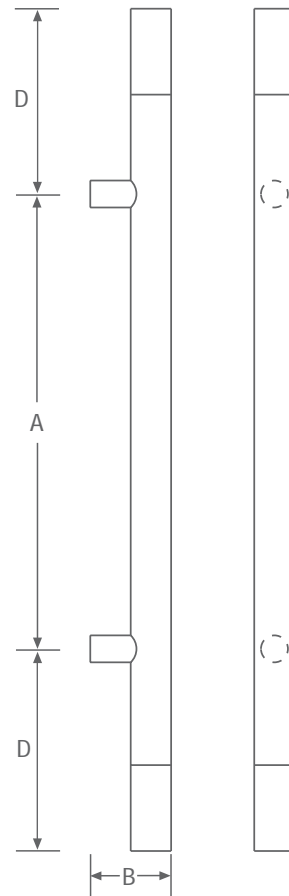

Style	Diameter $\varnothing$	Centres(A)	Projection(B)	Throw(C)	Overrun(D)	Finish	Code
ASH 586	38	up to 900	80	NA	150	Iroko	IR
ASH 586	50	up to 1800	95	NA	150	American Oak	AO
						Maple	MP
						Mahogany	BM
						Polished Stainless	PS
						Satin Stainless	SS

\*\* Extra fixing points may be required on some sizes.  
Contact our technical department for assistance.

### Ordering Guide

Please use the following guide as an example when placing an order.

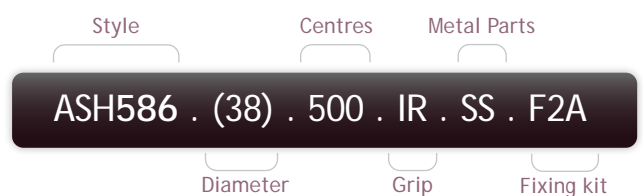

More ordering and fixing information can be found at the back of this catalogue

**ASH 586**